



360 QUAD SWIVEL KIDS SEESAW

MODEL# 2334KS
PRODUCT MANUAL - VERSION 5.23.01

FOR AGES:

3-9

WEIGHT LIMIT:

400 Lbs
100Lbs per seat

TO BUILD:



TOOLS NEEDED:

N/A



HOW-TO
VIDEOS ONLINE



Manual en español
ubicado en
GQAlpha.com

Spanish Manual
located at
GQAlpha.com

CUSTOMER SERVICE

GQAlpha.com • CustomerService@GQAlpha.com • 1-800-837-7732 • 12798 Perimeter Rd Ste C 106 Dallas Tx 75228



PATENT# D886932

CUSTOMER SERVICE INFORMATION

Thank you for purchasing: **360 QUAD SWIVEL KIDS SEESAW**

MODEL# 2334KS

If you have an issue with your item, do not return. Please report items that are damaged or missing parts to the manufacturer GQ Alpha within three days of delivery. Contact customer service at customerservice@gqalpha.com to open a ticket.

At GQ Alpha®, we want all of our customers to be completely satisfied with their purchase. Take time to review the contents of the product you have just received to make sure that all of the parts are included. If you find that any parts are missing or damaged, we will provide replacement parts at no charge within 30 days of purchase.

Please keep in mind that for select damaged part replacement requests, we will require a photo for submission.

Please Note: In the interest of better quality and value, we are constantly improving and updating our product information. Most up to date manuals, warnings and product information can be found at: <https://www.gqalpha.com/>

To order these parts, or if you have any other questions or concerns about this GQ Alpha product, please contact us at

GQalpha.com®
Phone: 1-800-837-7732
Email: CustomerService@GQAlpha.com
12798 Perimeter Rd Ste C 106 Dallas Tx 75228

Please be sure to include the following information when you contact Customer Service:

YOUR NAME: _____

YOUR MAILING ADDRESS: _____

YOUR EMAIL ADDRESS: _____

PRODUCT NAME: _____

PRODUCT MODEL#: _____

PART NUMBER _____

RETAILER WHERE PURCHASED: _____

DATE OF PURCHASE: _____

ORDER NUMBER: (If Available) _____

QUANTITY NEEDED: _____

SERIAL NUMBER: _____

LIMITED WARRANTY

GQ Alpha® warrants this product to be free from defects in workmanship and materials under normal use and conditions for a period of **90 DAYS FROM THE DATE OF ORIGINAL PURCHASE**. This Limited Warranty is not transferable and is available only for the original purchaser of the Product. The Company's obligation under this warranty is limited to replacing or repairing the Product, at the discretion of the company.

All warranty coverage extends only to the original retail purchaser from the date of purchase, GQ Alpha obligation under this warranty is limited to replacing or repairing, at GQ Alpha® option. All products for which a warranty claim is made must be received by GQ Alpha® and accompanied by sufficient proof of purchase (photocopy of the original store receipt, indicating the date of purchase). All freight and handling fees are the responsibility of the consumer to pay, both to and from GQ Alpha®. All warranty claims must be pre-authorized by GQ Alpha® pre-authorization can be obtained by calling 1-800-837-7732.

This warranty does not cover ordinary wear and tear, weathering, failure to follow directions, improper installation, improper maintenance, or acts of nature, (such as damage caused by wind, lightning, snow, water, or ice) weather damage, damage caused by unauthorized repair work or damage caused by improper use of the products are not covered by the product warranty. No other warranty beyond that specifically set forth above is authorized by GQ Alpha®.

GQ ALPHA® IS NOT RESPONSIBLE OR LIABLE FOR INDIRECT, SPECIAL OR CONSEQUENTIAL DAMAGES ARISING OUT OF OR IN CONNECTION WITH THE USE OR PERFORMANCE OF THE PRODUCT OR OTHER DAMAGES WITH RESPECT TO ANY ECONOMIC LOSS, LOSS OF PROPERTY, LOSS OF REVENUE OR PROFITS, LOSS OF ENJOYMENT OR USE, COST OF REMOVAL, INSTALLATION OR OTHER CONSEQUENTIAL DAMAGES. SOME STATES DO NOT ALLOW THE EXCLUSION OR LIMITATION OF INCIDENTAL OR CONSEQUENTIAL DAMAGES. ACCORDINGLY,

THE ABOVE LIMITATION MAY NOT APPLY TO YOU. THE WARRANTY EXTENDED HEREUNDER IS IN LIEU OF ALL OTHER WARRANTIES AND GQ ALPHA®, SPECIFICALLY DISCLAIMS ANY IMPLIED WARRANTY OF MERCHANTABILITY OR FITNESS FOR A PARTICULAR PURPOSE IS LIMITED IN ITS SCOPE AND DURATION TO THE TERMS SET FORTH HEREIN. SOME STATES DO NOT ALLOW LIMITATION ON HOW LONG AN IMPLIED WARRANTY LASTS. ACCORDINGLY, THE ABOVE LIMITATION MAY NO APPLY TO YOU. THIS WARRANTY GIVES YOU SPECIFIC LEGAL RIGHTS. YOU MAY ALSO HAVE OTHER RIGHTS, WHICH VARY FROM STATE TO STATE.

WHILE EVERY ATTEMPT IS MADE TO ENSURE THE HIGHEST DEGREE OF PROTECTION IN ALL EQUIPMENT, WE CANNOT GUARANTEE FREEDOM OF INJURY. THE USER ASSUMES ALL RISK OF INJURY DUE TO USE OR INSTALLATION. ALL MERCHANDISE IS SOLD ON THIS CONDITION, WHICH NO REPRESENTATIVE OF GQ ALPHA® CAN WAIVE OR CHANGE.

WARNINGS



IMPORTANT MESSAGE

Please read all of the warnings and directions below prior to assembly. This product comes equipped with warnings and instructions for the assembly, care, maintenance and use of the product. This information must be read by all supervisors and users before any person is allowed to use the product.

ADULT ASSEMBLY REQUIRED
CHOKING HAZARD - Small Parts
NOT for children under 3 years of age.

WARNING:

While every attempt is made to ensure the highest degree of protection in all equipment, we cannot guarantee freedom from injury. The user assumes all risks of injury due to use and installation. All merchandise is sold on this condition, which no representative of the company can waive or change.

PROPOSITION 65

THIS PRODUCT CAN POSSIBLY EXPOSE YOU TO CHEMICALS INCLUDING DI(2-ETHYLHEXYL) PHTHALATE (DEHP), WHICH IS KNOWN TO THE STATE OF CALIFORNIA TO CAUSE CANCER AND BIRTH DEFECTS OR OTHER REPRODUCTIVE HARM. FOR MORE INFORMATION GO TO WWW.P65WARNINGS.CA.GOV.

⚠ WARNING LABEL LOCATIONS

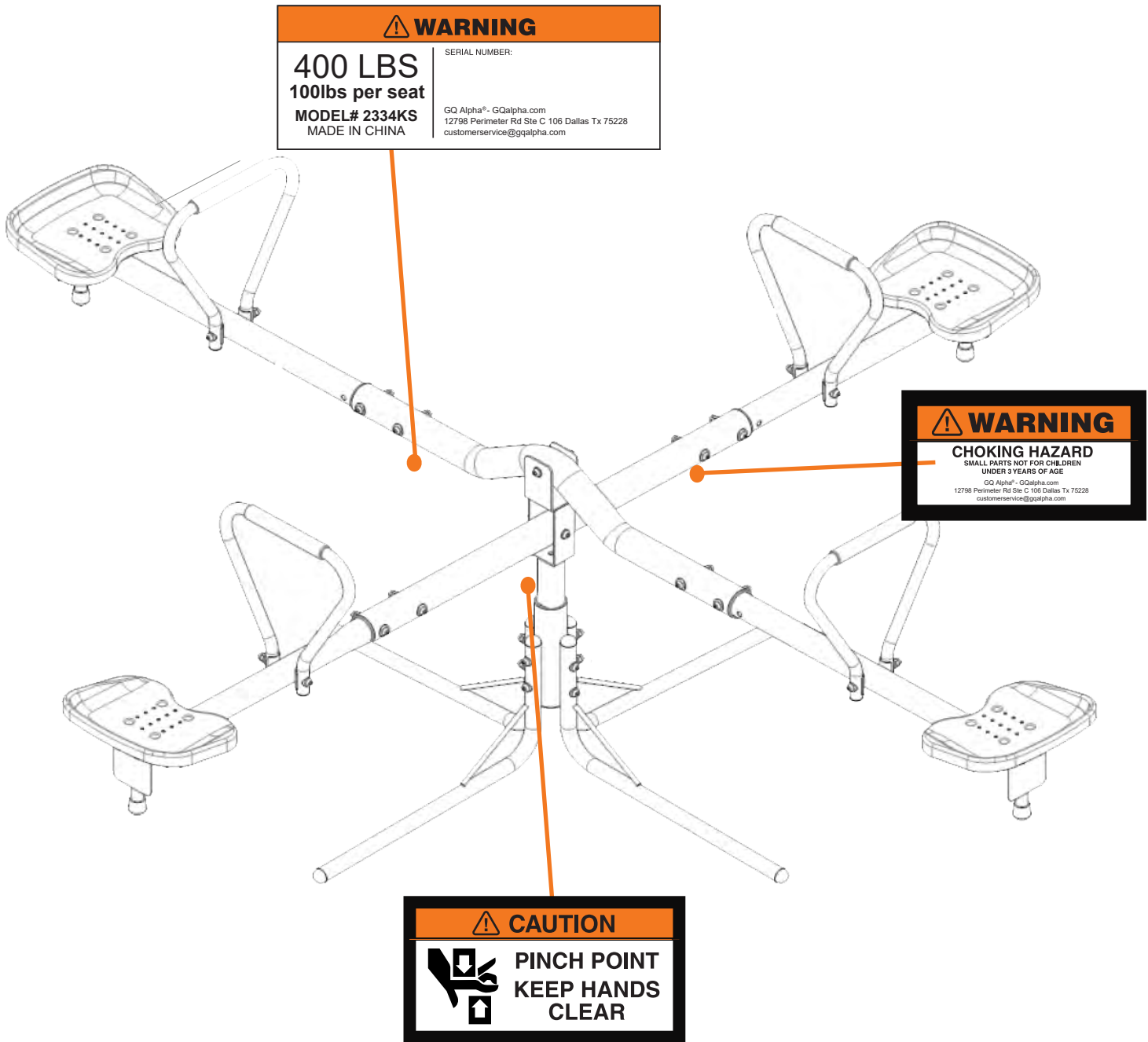

The labels shown on this page have been attached to the product in the indicated location.

Note: The labels are not shown in actual size.



WARNINGS & SAFETY INFORMATION

Please read these warnings and the information in this manual in its entirety.

Failure to comply with the following instructions may increase the risk of serious injury and/or death:

- The owner and supervisors of this product are responsible to make sure all users are aware of the warnings and use specified in this manual.
- Ensure the product has been assembled correctly, per the instructions in the manual.
- This unit must be assembled and disassembled by **ADULTS ONLY**.
- This See Saw is suitable for use by most children 3 to 9 YEARS OF AGE.
- Never use this product in any manner other than its intended use.
- DO NOT exceed the **MAXIMUM WEIGHT** limit of 400bs (100 Lbs per seat) regardless of age.
- This unit has a **MAXIMUM FALL HEIGHT** of 43.5"
- DO NOT install this equipment over concrete, asphalt, or any other hard or rough surface. The See Saw should always be installed over an appropriate, stable surface (rubber mat, grass, etc).
- ALWAYS locate this equipment on a stable, level surface **AT LEAST 7 feet** away from any structure, obstruction, or possible hazard(s) such as walls, pools, power lines, overhangs, other playground equipment, driveways, hard surfaces and/or roadways.
- Children must be supervised at all times when using this equipment. **DO NOT** leave children unattended at any time.
- DO NOT attach items not specifically designed for this purpose. Especially in the case of jump ropes, chains, clotheslines, pet leashes and cables. These may cause a strangulation or physical hazard.
- DO NOT allow children to stand on the seesaw.
- This See Saw is only designed for family residential use. It is NOT intended for commercial applications and/or use in public areas such as schools, parks, nurseries, day schools, day cares, etc. This will VOID the warranty completely.
- DO NOT allow more than one child on each See Saw seat at a time.
- Instruct children to always be sure that the area under and around the seesaw is clear of any persons, pets or obstructions before using.
- DO NOT allow children to wear glasses or helmets when using the See Saw, including bike or other sports helmets.
- DO NOT allow children to wear loose fitting clothing, clothing with straps/loops, backpacks or wear and/or hold accessories with straps or loops, or any article of clothing or accessory with sharp edges which may present a hazard or become snagged or caught on the See Saw during use. Serious injury and/or accidental strangulation may occur.
- DO NOT place objects on or under the see saw, or allow people and pets to stand or sit on, near or under the See Saw when in use.
- DO NOT allow children to stand on the frame, or hang from the steel tubing – this can cause serious injury.
- DO NOT use in adverse weather conditions, while the seats are wet, or in poorly lit conditions.
- Children must ALWAYS remain securely seated, in the forward facing position when using.
- ALWAYS secure the See Saw against unsupervised use.
- ALWAYS wear the appropriate footwear (i.e. closed toe shoes) when using the See Saw.
- Before each use of this product and twice per month, inspect and replace any worn, loose, defective or missing parts and tighten all hardware. All moving parts should be lubricated with a household lubricant.
- It is important to check the entire See Saw to ensure the Frame Tubing, Protective Coverings, and Seats are steady and all parts and tubing caps are attached in good condition. If any loose, cracked, missing, or otherwise damaged components are found, cease use of this item immediately.
- Check metal parts for rust. If rust is found, sand and repaint using a non-lead based paint. If removed for winter storage, reinstall any plastic parts before allowing use.
- Immediately discontinue use if any breakage to the frame or other parts of this product are found. Failure to do this may result injury and/or further damage to the product.
- Rake and check depth of loose fill protective surfacing materials to prevent compaction and maintain appropriate depth. Replace as necessary.
- At the end of the play season or when the temperature drops below 40 degrees Fahrenheit, or in adverse weather conditions, it is recommended this unit must be disassembled and/or stored indoors.
- Misuse and abuse of this product is dangerous and can cause serious injuries.
- Keep this product away from all heat sources and fire sources.
- The frame of this product is made of steel and it will conduct electricity. No electrical equipment (lights, heaters, etc.) should be permitted on or around the product under any circumstance.
- Before each use of this product, inspect the entire assembly and replace any worn, defective or missing parts.
- No modification should be carried out to this product or any of its components unless specified in this manual. Any modification could lead to damage to the product or result in a personal injury.
- Please read and refer to other warnings and use information in the product instructions before use.
- Dispose of all packaging materials safely and per local ordinance.
- Keep this manual and safety instructions for future reference.

CONDITIONAL SAFETY INFORMATION

This product is designed and manufactured to provide you and your family with many years of fun and exercise, but for your benefit and safety, please read this manual carefully and in full before assembling and using your product.

- **IMPORTANT:**

Children must not use the product if they have a medical history of neck or back injuries or certain mental or physical conditions – an existing condition dramatically increases the risk of serious injury or death.

- No modification should be carried out to the product or any of its components. Any modification could lead to damage to the product or result in a personal injury.
- DO NOT allow more than two (2) children on the product at a time.
- The frame of your product is made of steel and it will conduct electricity. No electrical equipment (lights, heaters, extension cords, household appliances, etc.) should be permitted on or around the equipment under any circumstances to avoid the risk of electrocution.
- As your product swivels and is raised off the ground, there is the risk of falling. Children should be assisted when using this product to make sure they understand how to use it properly and safely.

- **WEATHER CONDITIONS:**

Special care should be taken as weather conditions change. In particular, a wet product is too slippery for safe playing. Gusty or severe winds can cause children to lose control. To reduce the chance of injury, use the product only under appropriate weather conditions. In cold weather, tongues and lips can stick to metal at sub zero temperatures. In warmer and sunnier weather, parts can become extremely hot, and the temperature should be regularly checked during play, especially metal parts.

- **HIGH WINDS:**

It is possible for the product to be blown about by high wind. If you anticipate high winds, the product must be moved to a sheltered location, or be disassembled. Pure Fun™ is not responsible for any damage to property or products resulting from wind or extreme weather.

PARTS LIST

1- Main Center Pole

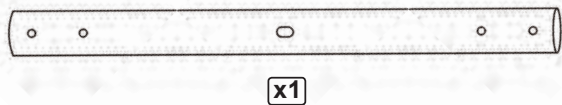

2 - Main Side Bar

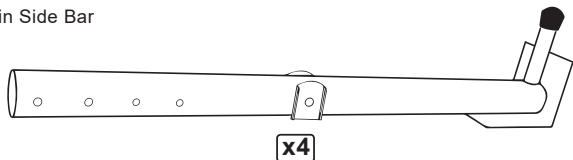

3- Curved Main Bar

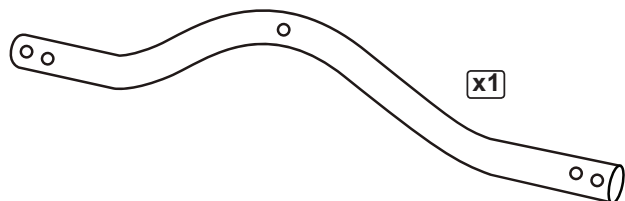

4- Leg with Upper Openings

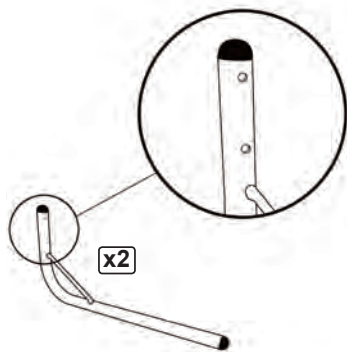

5- Leg with Lower Openings

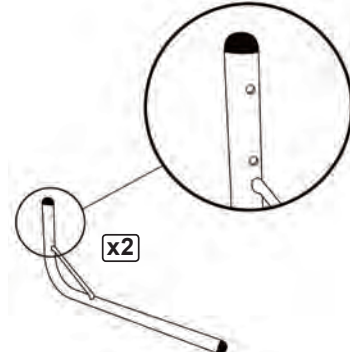

6- Handle Bar with Foam

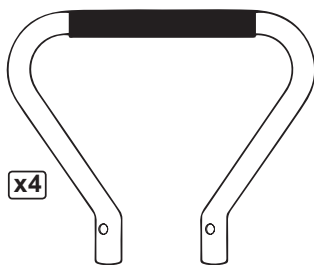

7- Seat

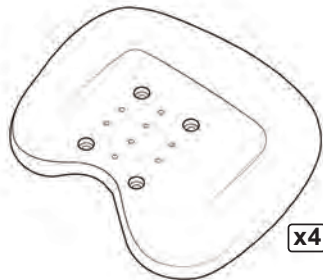

8- Upper Support Tube

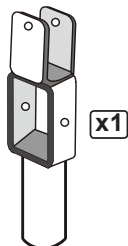

9 - Lower Support Tube



10 - M6 Bolt 20mm



11 - M8 Bolt 65mm



12 - M8 Bolt 70mm



13 - M8 Bolt 95mm



14 - M8 Bolt 115mm



23 - Allen Wrench

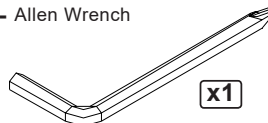

24 - Wrench

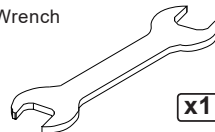

25 - Wrench 2

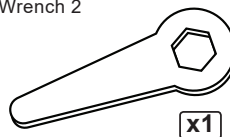

15- M8 Large Curved Washer



16- M8 Small Curved Washer



17- M8 Flat Washer



18- M6 Flat Washer



19- M8 Spring Washer



20- M6 Spring Washer



21- M8 Nut

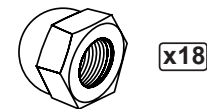

22- M6 Nut



ASSEMBLY INSTRUCTIONS

To assemble this product properly, you must follow all instruction steps below. Do not attempt to alter any of the frame components or parts or skip any steps below. Use gloves to protect your hands from pinch points during assembly.

STEP 1

14 - M8 Bolt 115mm

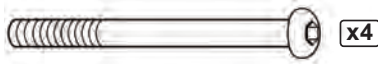

16- M8 Small Curved Washer



19- M8 Spring Washer

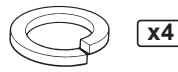

21- M8 Nut

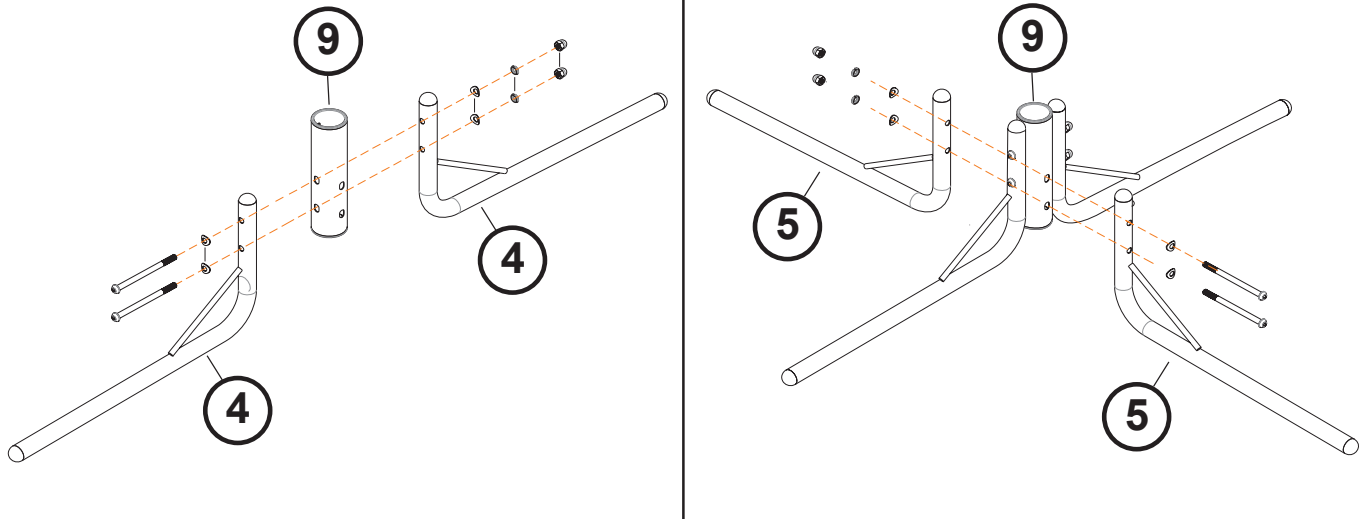
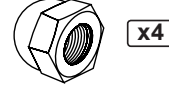

STEP 2

12 - M8 Bolt 70mm



17- M8 Flat Washer



19- M8 Spring Washer

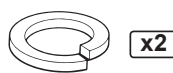

21- M8 Nut

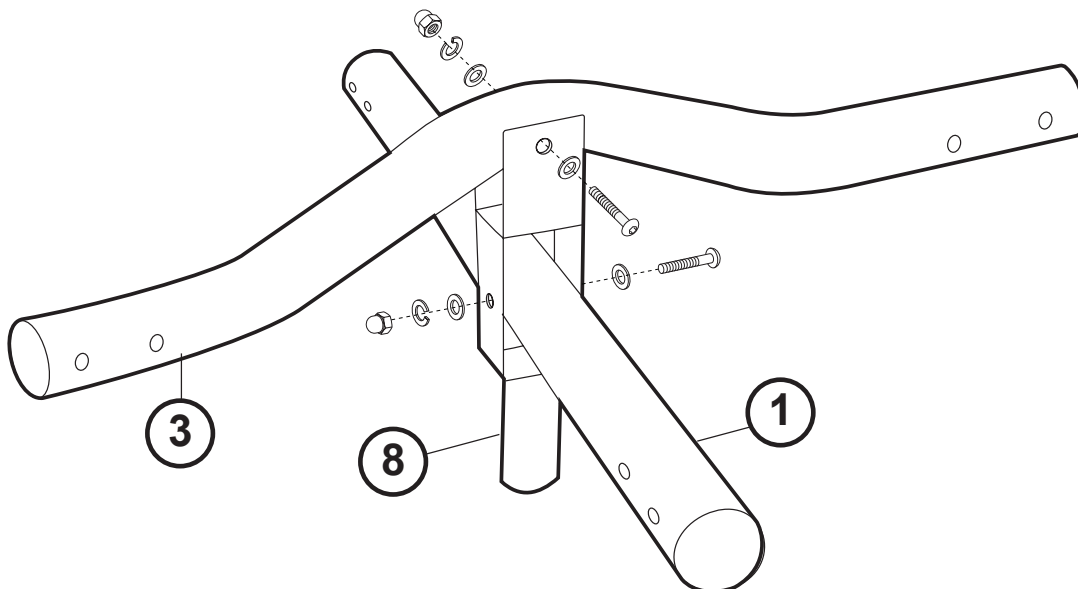
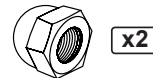

ASSEMBLY INSTRUCTIONS

STEP 3

10 - M6 Bolt 20mm

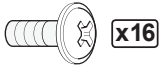

18- M6 Flat Washer



20- M6 Spring Washer



22- M6 Nut

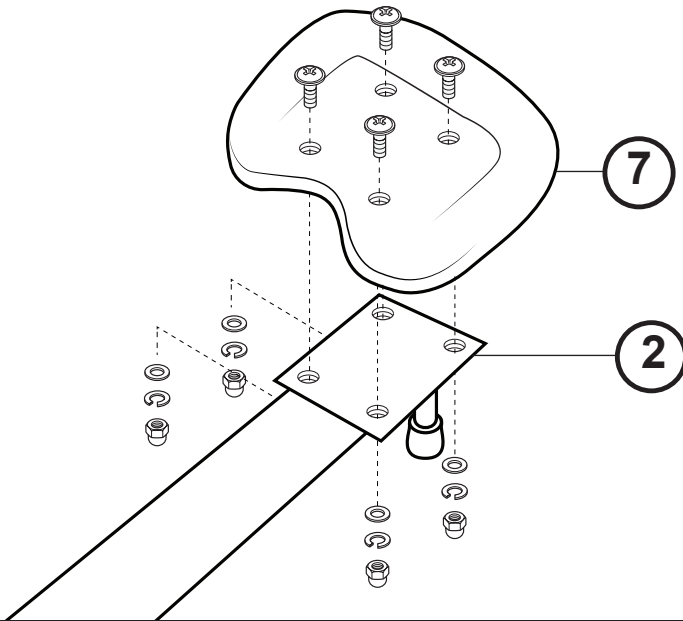

STEP 4

13 - M8 Bolt 95mm



16- M8 Small Curved Washer



19- M8 Spring Washer

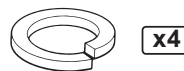

21- M8 Nut

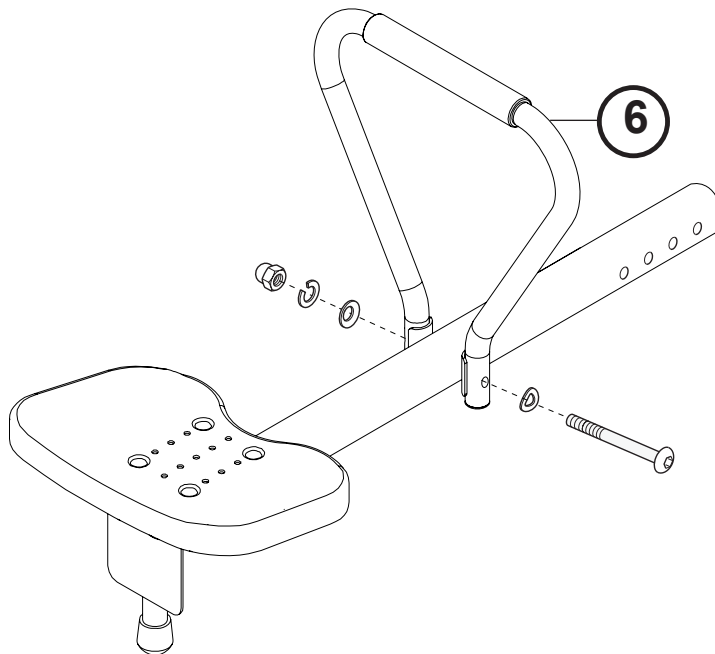

ASSEMBLY INSTRUCTIONS

STEP 5

11 - M8 Bolt 65mm



15- M8 Large Curved Washer



19- M8 Spring Washer

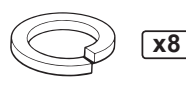

21- M8 Nut

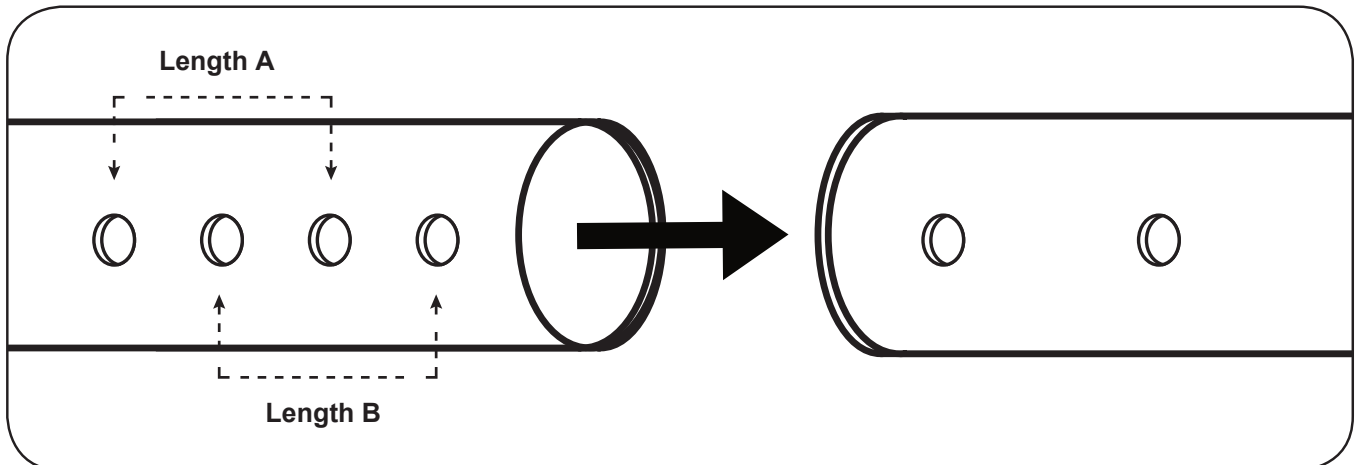
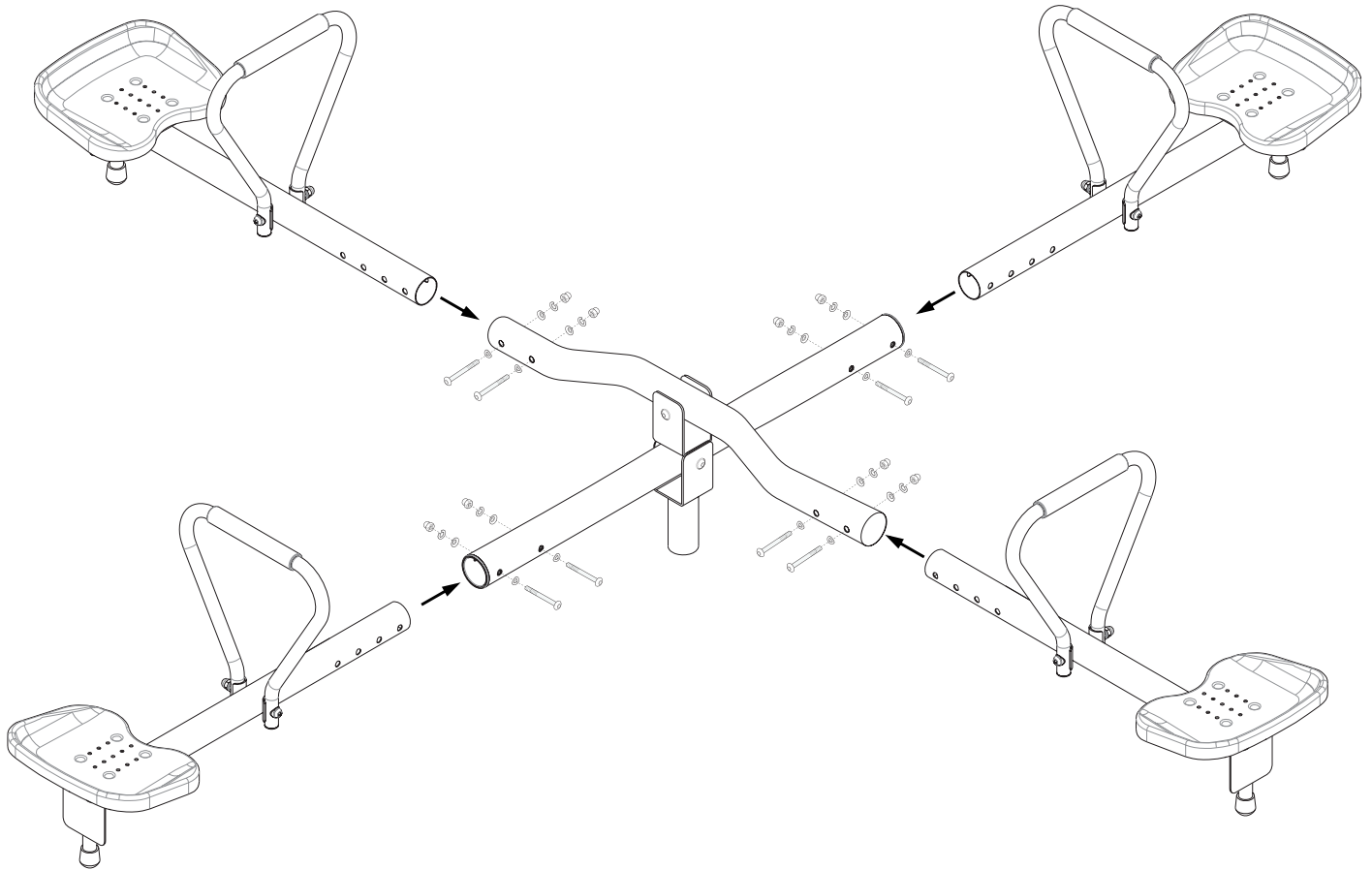

ASSEMBLY INSTRUCTIONS

STEP 7

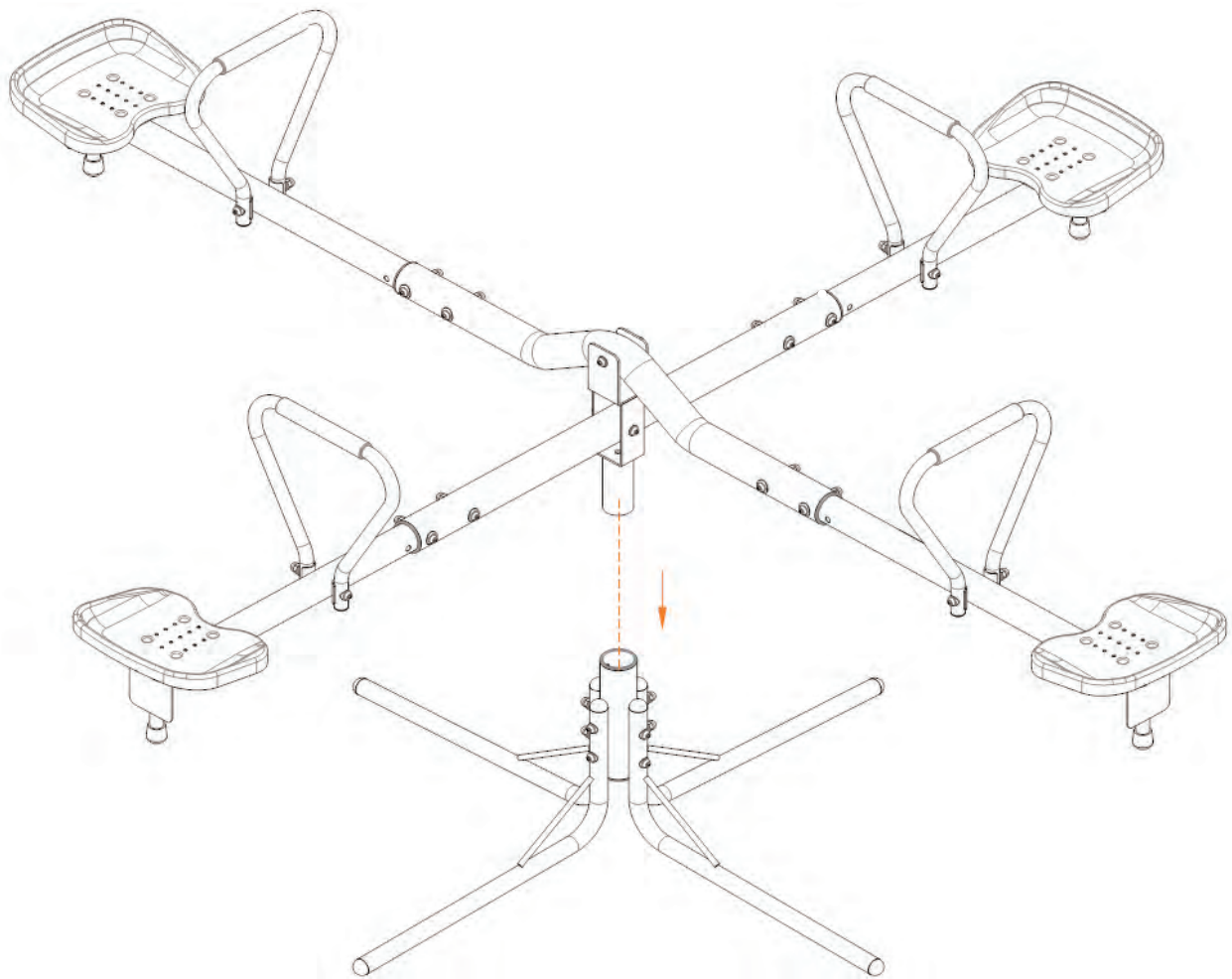

DISASSEMBLY INSTRUCTIONS

To disassemble the seesaw, follow all the installation steps in reverse order. Use gloves to protect your hands from pinch points during disassembly.

FREQUENTLY ASKED QUESTIONS

Question: "How should I clean my seesaw?"

Answer: you should clean the Seesaw with a solution of warm water and Non- Corrosive/Abrasive soap. Dampen a rag with this solution and wipe completely dry before using.

Question: "A seat seems loose, what should I do?"

Answer: Make sure the Bolts/Nuts under the plastic seat are secure.

Question: "Something was missing from the packaging," "I need to purchase a replacement part" or "I discovered a damaged piece. What should I do?"

Answer: Contact customer service. You must have proof of purchase and/or order confirmation available to be considered for warranty replacement. You must report missing pieces within 30 days of purchase.

CARE & MAINTENANCE

- Before each use of this product, inspect the entire assembly and replace any worn, defective or missing parts.
- The following conditions could represent potential hazards: Missing, improperly positioned, or insecurely attached seats; A bent or broken frame; Cracked or broken seats. Cease using seesaw immediately and secure it against unauthorized use if any of these conditions are present.
- Regularly check to see if the steel tubes, seats, backrests and other parts are tightened and completely secure. Replace worn & damaged parts if found and if necessary, secure from use until replacement parts can be obtained.
- If the paint is chipped, we recommend you lightly rub the damaged area and cover using a non-toxic enamel paint.

Cleaning your Playground Equipment

- High touch surfaces made of plastic or metal, such as grab bars and railings should be cleaned routinely.
- Do NOT use bleach as it may cause colors to fade.
- Use wet towel or cloth with mild soap and water solution to wipe down metal parts, seats and handlebar. Dry Immediately and do not allow children to use until completely dry.
- To disinfect surfaces - use a 70% / 30% Rubbing Alcohol to Water mix to clean seat and handlebar surfaces. The surface must remain visibly wet for at least 4 minutes, allowing it to dry on its own. After 4 minutes, the surface may be rinsed thoroughly and wiped dry to eliminate water marks. This solution will lose its effectiveness in about 24 hours, so a new batch must be made each day.